Expression™ Interlocking Panel
No1 Architectural Panels System

INSTALLATION GUIDE

Non-Cyclonic

Expression™ panel installation

Important Note:

No1 Architectural Panels recommends you refer to the most recent release of this manual, as changes might be made for improvement purposes. If unsure which version of the manual you have, please contact No1 Architectural Panel Systems for assistance.

This manual should be read in conjunction with related Australian Standards, and all installation works must be carried out in accordance with the National Construction Code of Australia and the following standards:

- AS 1562.1 - design and installation of sheet roof and wall cladding
- SA HB 39:2015 - installation code for metal roof and wall cladding
- AS 2180 - metal rainwater goods - selection and installation
- AS 2179.1 - specification of rainwater goods, accessories, and fasteners metal shape or sheet rainwater goods, and metal accessories and fasteners
- AS 3500.3 - plumbing and drainage stormwater drainage

Usage Terms

By utilising this manual, you agree to abide by the specified terms and conditions. No1 Architectural Panel Systems, including its employees, agents, consultants, officers and subcontractors, does not make explicit or implied claims regarding the suitability of the information and data provided for your specific needs, and will not be liable for any work done outside the recommendations in this manual and/or compliance with NCC & Australian Standards.

This manual offers clear and structured information on products, installation details and recommended practices. It is essential for users to interpret this information correctly. If a third-party product is suggested, it is recommended to the user to verify its qualities and capabilities with the manufacturer before use. In case of any uncertainty, seek clarification.

Should on-site requirements necessitate adjustments to the details provided, users must ensure compliance with the abovementioned standards. It is your responsibility to ensure that your chosen design aligns with your requirements, purchased products, site constraints, and construction capabilities.

Technical Specifications

Panel height	25mm
Standard panel cover	300mm and 500mm
Minimum sheet length	750mm
Maximum recommended sheet length	4000mm*
Custom pan widths	Available. Please consult with our APS team - additional design parameters might be required
Fixing	Concealed fixed**

Expression™ Interlocking Panels are tested and certified to comply with AS 1562.1:2018 - Design and installation of sheet roof and wall cladding - Metal. It replaces AS 1562.1:1992

*Considering the characteristics of Expression™ as a direct fixing architectural panel (without clips), extended panel lengths may exhibit increased vulnerability to the manifestation of oil canning.

** Exposed fixing may be required for wider panels - see installation notes on page 7

Use of Authentic Materials

We exclusively mention authentic materials and products produced by No1 Roofing & Building Supplies and sold under our brand labels. Please apply our suggestions solely to our products, as they derive from thorough testing of our designs, base metal thicknesses, and material coatings and finishes.

General

- A. Provide components required for a complete metal cladding panel assembly including trim, capping, corner, flashing, sealants, gaskets, fillers and similar items. Match material and finish of metal cladding panels, unless otherwise indicated.
- Flashing: Provide flashing at bottom, tops, corners, transitions, window surroundings and door surroundings fabricated of same metal as metal roof panels.
- B. General: Provide metal cladding panels of full length from floor level to soffit / awning underside / internal ceiling lining.
- Field cutting of metal roof panels by torch, plasma cutter or saw blade is not permitted.
 - Mechanically fasten top cappings, corner capping and bottom flashings / toe mould
- C. Fasteners:
- Panel fixing: It is recommended to use minimum class 3, 10g-16x16 wafer head for steel batten fixing, or 10-12 wafer head type 17 screws. Hybrid tek architectural low profile screws can also be used.
- D. Metal protection: Where dissimilar metals will contact each other or corrosive substrates, protect against galvanic reaction by painting contact surfaces with bituminous coating, by applying rubberised-asphalt underlayment to each contact surface, or by other permanent separation as recommended by metal roof panel manufacturer. Please use a suitable fastener

Whilst this will work for the majority of metals, there are instances where incompatibility with coatings / underlayments can also occur - for example: titanium zinc and bitumen are incompatible. If you are unsure, please contact No1 APS team.

Field-assembled Expression™ panel installation

- A. Metal wall cladding panels: Fasten metal wallpanels to a solid substrate as per the manufacturer's engineering report or engineer recommendation based on project location and wind load requirements.
- Fixing spacing: Maximum 600mm centres for both internal and end span. For specific wind load requirements, please consult with our No1 APS team.
 - Install panels to an appropriate substrate by using class 3 (minimum recommended grade), low profile fasteners fixed into the fixing tab on the panels female edge using recommended spacing as per above.
 - Insert panel male edge inside panel female edge slot for panel engagement.
- B. Metal soffit panel: Provide metal soffit panels that are the full width of the soffit. Install panels perpendicular to the support framing.
- Flash and seal panels with weather closures where metal soffit panels meet walls and at the perimeter of all openings.
- C. Installation on plywood requires the following:
- 20mm continuous unobstructed air gap must be incorporated beneath the plywood substrate for ventilation.
 - Breathable waterproofing membrane fixed to outer/external side of plywood substrate.
 - Expression™ wall cladding is installed on a minimum 15mm plywood substrate. (For projects in BAL areas, please consult with our team for alternative / appropriate substrate options).
 - Concealed fasteners attached directly into plywood substrate.
 - Insert panel male edge inside panel female edge slot for panel engagement.

Delivery, storage and handling

For a safer installation, it is recommended that you wear protective gloves whilst handling metal panels and flashings to avoid personal harm and marks on material (i.e.: marks caused by sunscreen). Be aware metal panels have sharp edges and should be treated carefully. Whilst holding a panel, assure even support throughout the length of it (i.e. hold it with arms open, to avoid creating uneven pressure on panels and flashings), and seek help when carrying longer pieces to lower risk of creasing and scratches.

Always inspect delivered items thoroughly to ensure there are no missing items and all goods are in good condition prior to starting installation. When laying metal sheets and flashings on ground, allow the sheet to naturally hang towards the ground with even support and avoid laying goods on hard/rough surfaces that could potentially scratch or damage them.

Goods should be stored in a safe area, off the ground high enough to allow for air circulation underneath and to prevent rising water from contacting products. If covered, allow for air circulation between draped edges of tarpaulin and slightly elevated on one side as to allow for proper drainage until ready for installation. Prolonged storage is not recommended.

Safety on site

Carrying long and heavy panels can be challenging exercise on a busy job site. Always be aware of safety laws and comply with safe working conditions imposed by each site. Be aware of others whilst carrying panels throughout a site and avoid resting panels in vertical position in case wind could blow them down. Always be extra careful and consider postponing installation in case of bad weather and windy conditions.

Cleaning and protection

- A. Unless otherwise indicated in manufacturer's written installation instructions, remove temporary protective coverings and strippable films if applicable as metal roof panels are installed. On completion of metal cladding panel installation, clean finishes surfaces as recommended by metal panel manufacturer. Maintain in a clean condition during construction.
- B. To prevent rust staining, remove any fillings caused by drilling or cutting immediately from finished surfaces.

Oil canning

Whilst usually undesirable, oil canning is a common natural occurrence to all metals and results from the natural movement of the panel caused by its expansion and contraction once exposed to temperature variation.

No1 Architectural Panel Systems takes all possible measures to manufacture panels with maximum quality control resulting in an aesthetically flat looking panel, and for this reason oil canning on installed panels will not be considered a cause for panel rejection.

Please speak to No1 for assistance on how to mitigate oil canning on your installation.

Expression™ Panel Characteristics

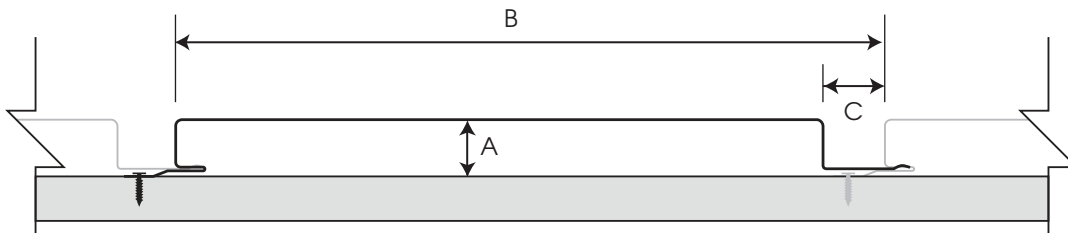
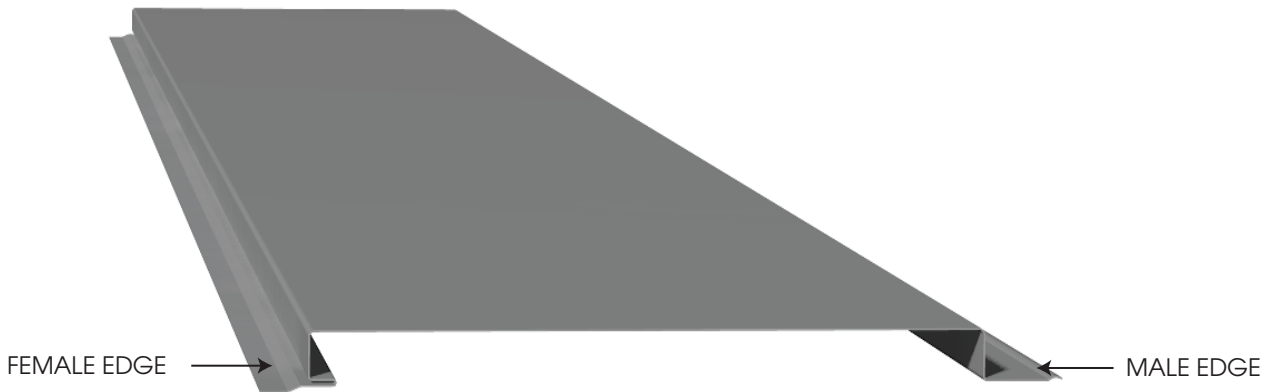

Module	25 x 300	25 x 500
Panel Height (A)*	25mm	25mm
Panel Cover (B)**	300mm***	500mm***
Gap (C)	10 or 15mm	10 or 15mm

*Panel height is not customisable

**Custom modules available. Please consult with No1 APS team

***Approximate cover. Tolerances apply



Index

Expression™ Panel Overview	2
Panel Characteristics	5
Fixing Specification	7
Panel notching and stop end	8
Wall cladding flashing details on battens	9
Wall cladding flashing details on plywood	24

Expression™ Fixing Specification



Diagram showing screw engagement on vertical Expression™ panels over steel battens. Timber battens and plywood can also be used as substrates

FASTENER POSITION

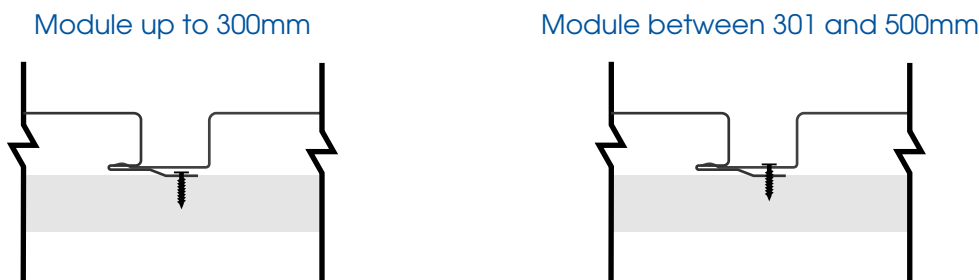

RECOMMENDED MAXIMUM FIXING SPACING

Expression™ Base Material	End Span	Internal
Steel 0.55BMT or 0.70BMT G300	600mm	600mm
Corten Steel 0.55BMT G300	600mm	600mm
Aluminium 0.7 or 0.8BMT 5005 H34	600mm	600mm

Expression™ Panel Preparation - Notching & Stop End

Adding stop ends to Expression™ panels are an optional step that can enhance panel aesthetics, hide panel terminations, as well as increase overall panel flatness.*

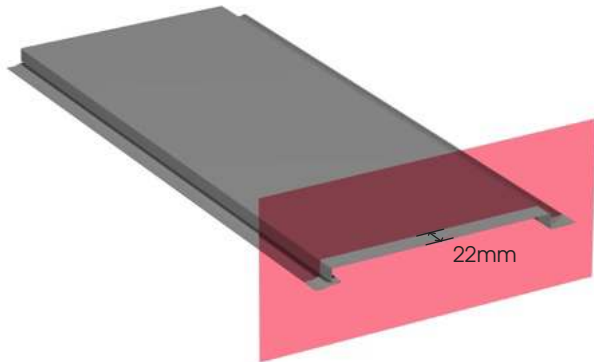

- 1** Mark end of panels with a line 22mm offset from the panel end

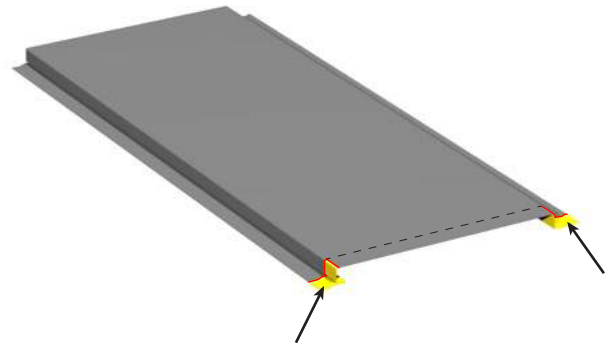

- 2** Use a pair of snips to cut panels (on red lines) and notch off side ends, leaving only the panel face

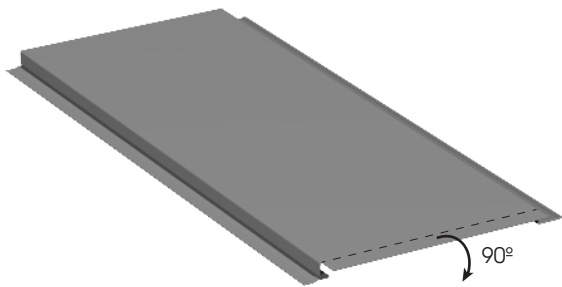

- 3** Use hand seamers or folding tools to bend panel face at marked line 90 degrees down

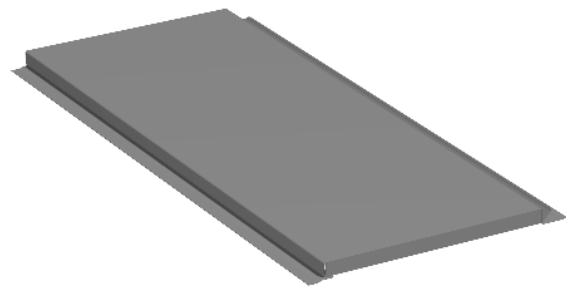

- 4** Repeat the process as required. This procedure can be applied to both ends of panel if necessary.

* Ensure the use of correct tools for a better outcome.

* In case it is not possible to prepare panels on site, Expression™ Panels can be supplied:

- a) Already notched
- b) Already notched and stop ended



Expression™ Wall Cladding Flashing details on battens

Wall Cladding - Vertical Application Installation on Battens

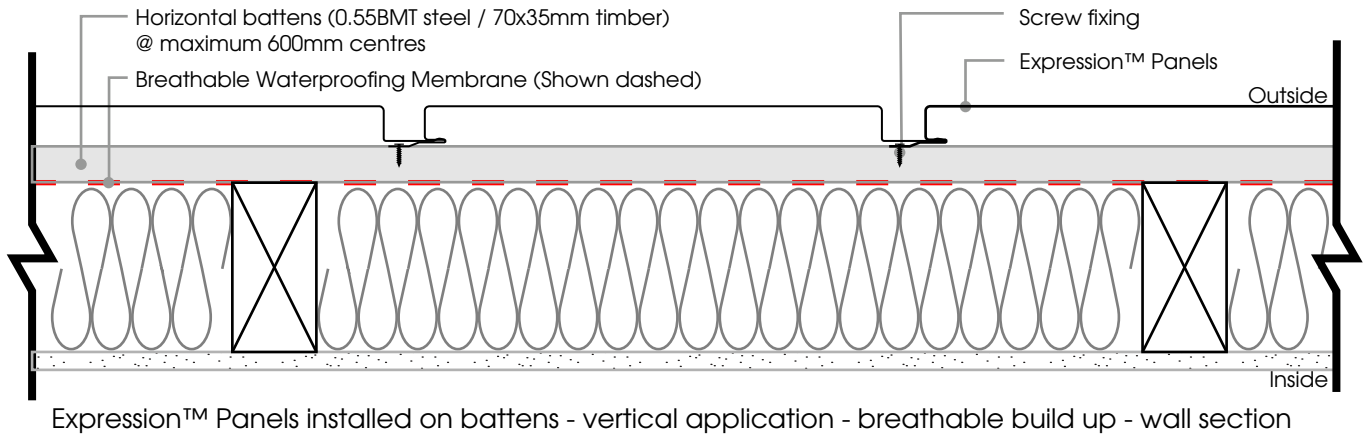

Installation Steps

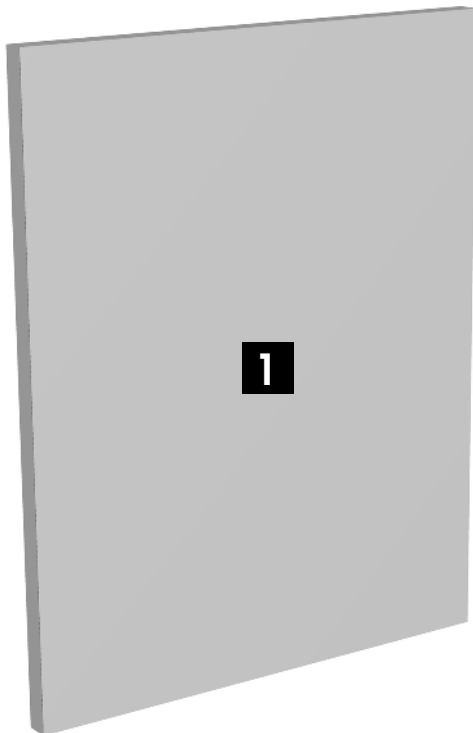

- 1** Ensure wall structure is levelled and plumb.
*Wall structure not shown for clarity.



- 2** Apply a layer of breathable waterproofing membrane to the structure. Ensure structure is protected and sealed.

Wall Cladding - Vertical Application Installation on Battens



3 Install tophats horizontally over membraned wall, at maximum 600mm centres.



4 Install auxiliary tophats for flashings support on top and bottom of wall.



5 Install Top Flashing and Toe Mould Flashing.



6 Install Side Wall Flashing, and then install Starter Strip. Seal Side Wall Flashing against the wall.

Wall Cladding - Vertical Application Installation on Battens



7 Slide up the first Expression™ panel into the top flashing.

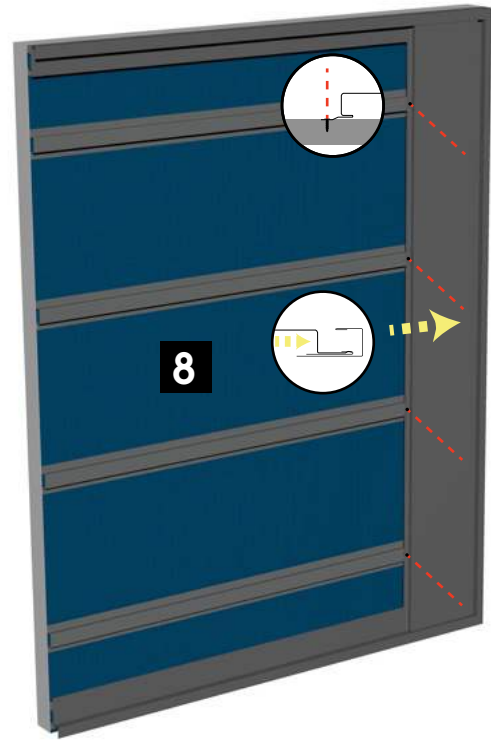

8 Slide Expression™ panel sideways into starter strip, and fix Expression™ panel to the tophats using low profile wafer head screws.

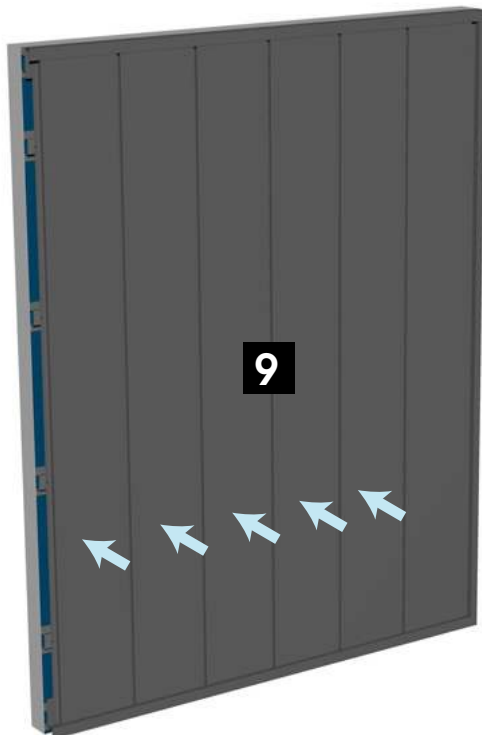

9 Repeat step 8 as required until the wall is covered.

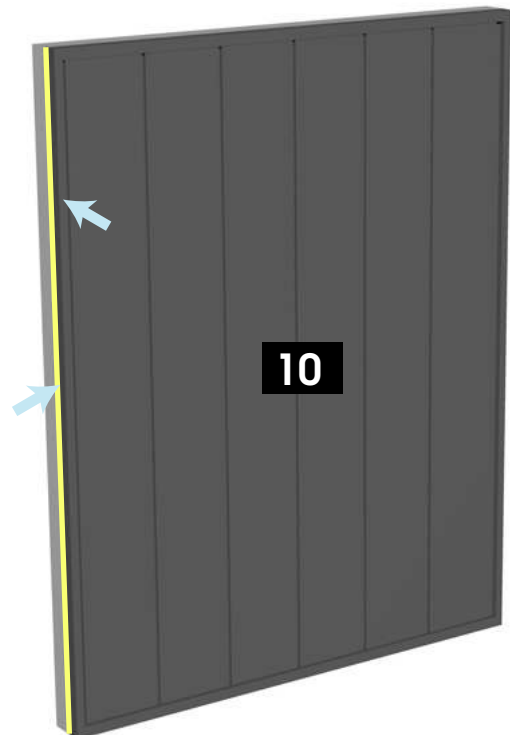

10 Install custom wall flashing over last Expression™ panel, using butyl tape and screws with washer. Seal custom wall flashing against the wall.

Wall Cladding - Vertical Application Flashing Details - Installation on battens



Above are the most common flashing profiles for the Expression™ panel system. On site requirements might change flashings shape and dimensions. It is the responsibility of the installer to ensure installation is compliant to Australian Standards.

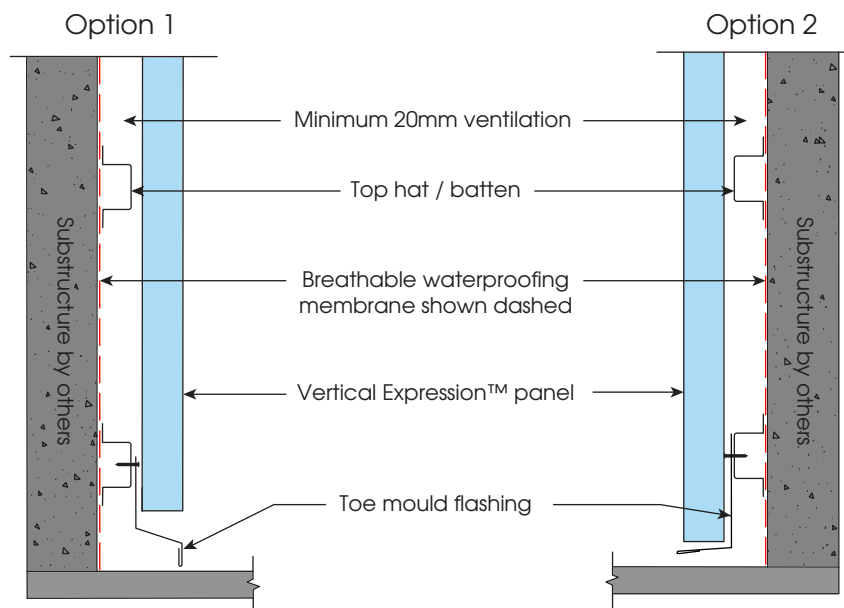

Typical bottom flashing detail - cross section

Wall Cladding - Vertical Application Flashing Details - Installation on battens

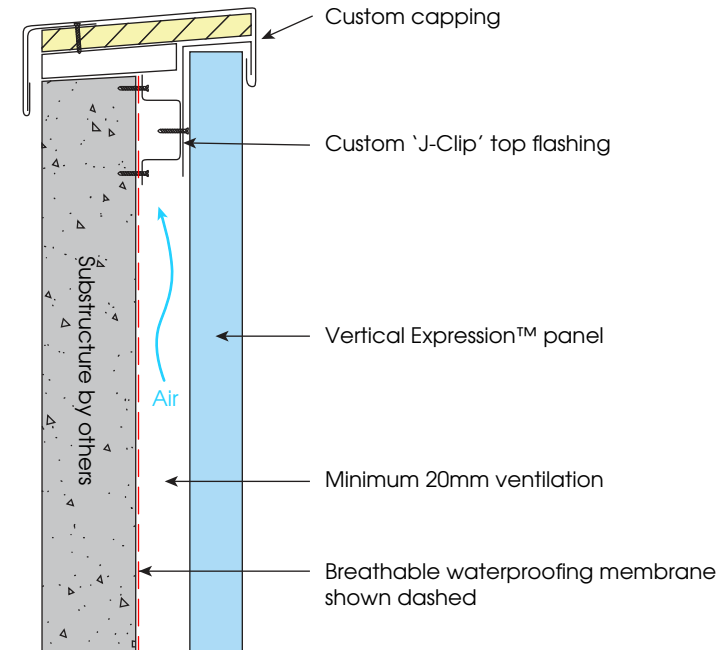

Typical parapet detail

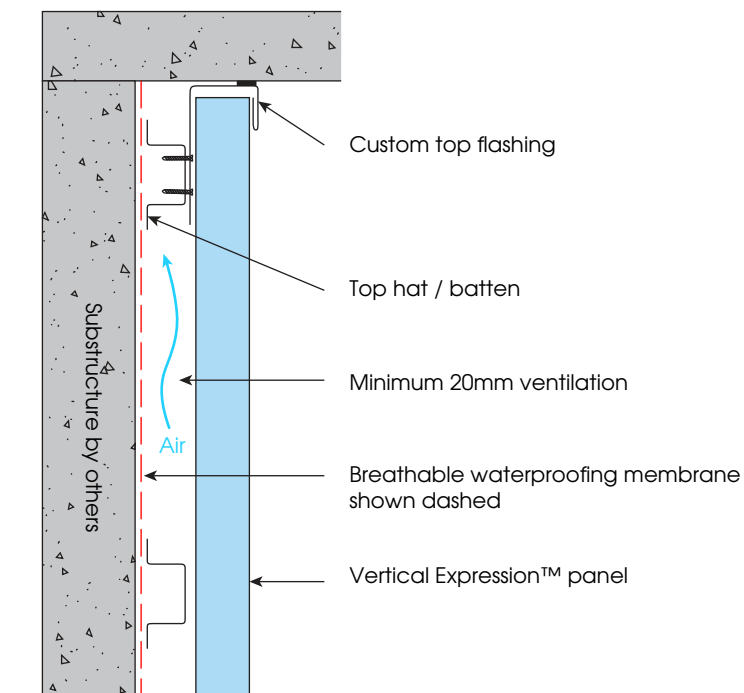

Typical top of wall detail

Wall Cladding - Vertical Application Flashing Details - Installation on battens

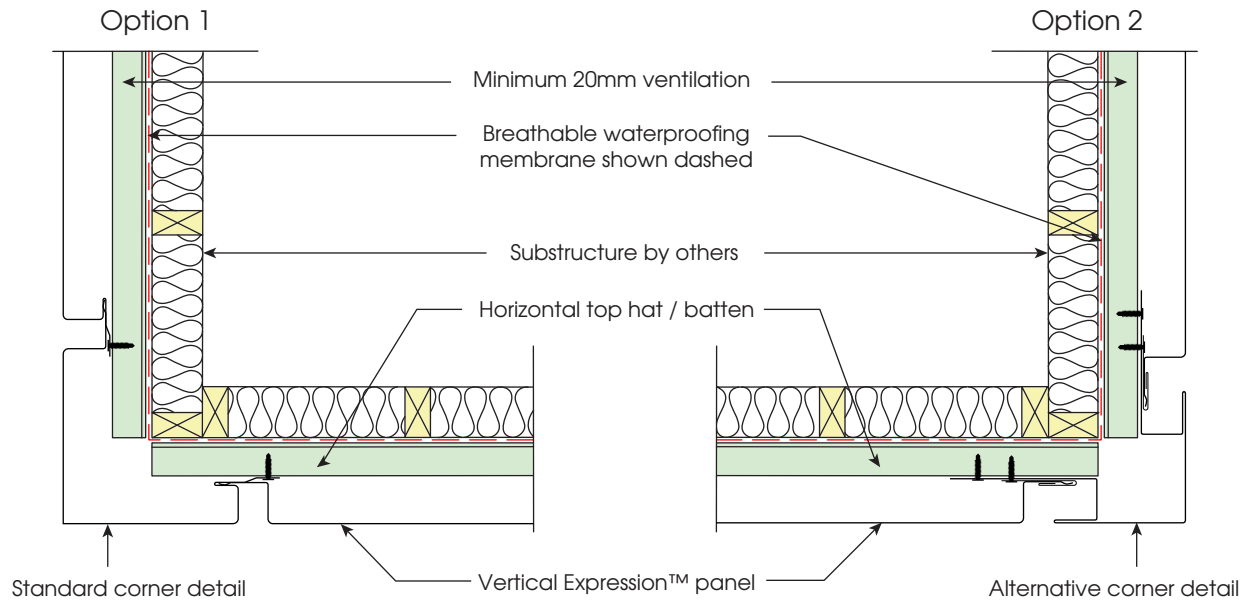

Typical external corner detail

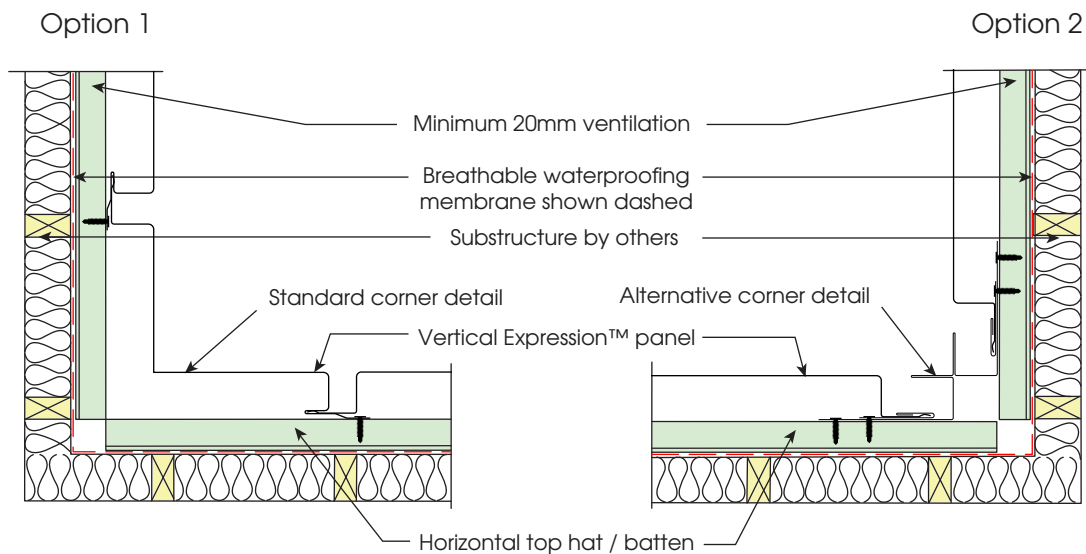

Typical internal corner detail

Wall Cladding - Vertical Application Flashing Details - Windows

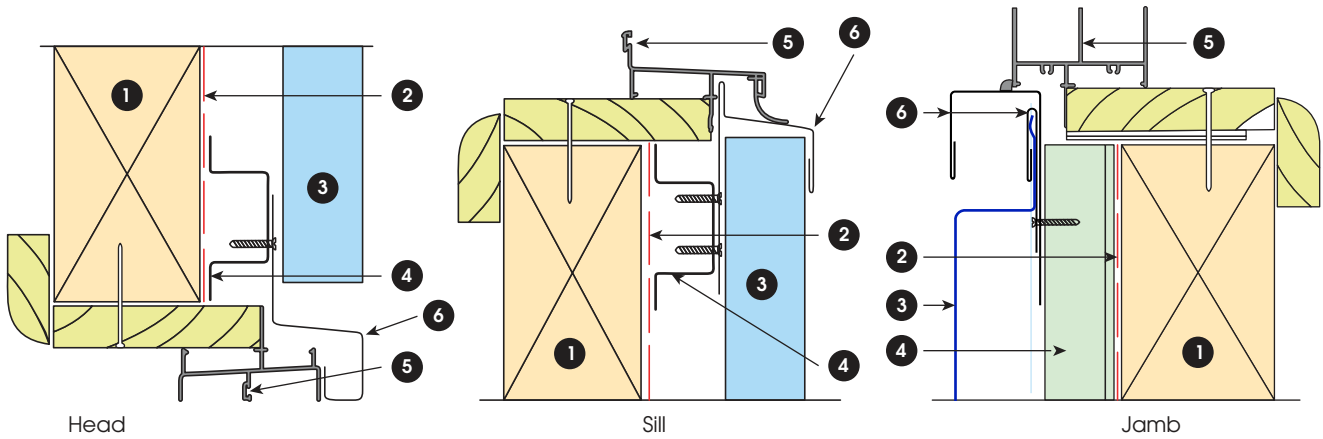

- 1 Substructure supplied by others
- 2 Breathable waterproofing membrane shown dashed
- 3 Vertical Expression™ panel
- 4 Top hat or batten
- 5 Window supplied by others
- 6 Flashing

Typical timber reveal window detail

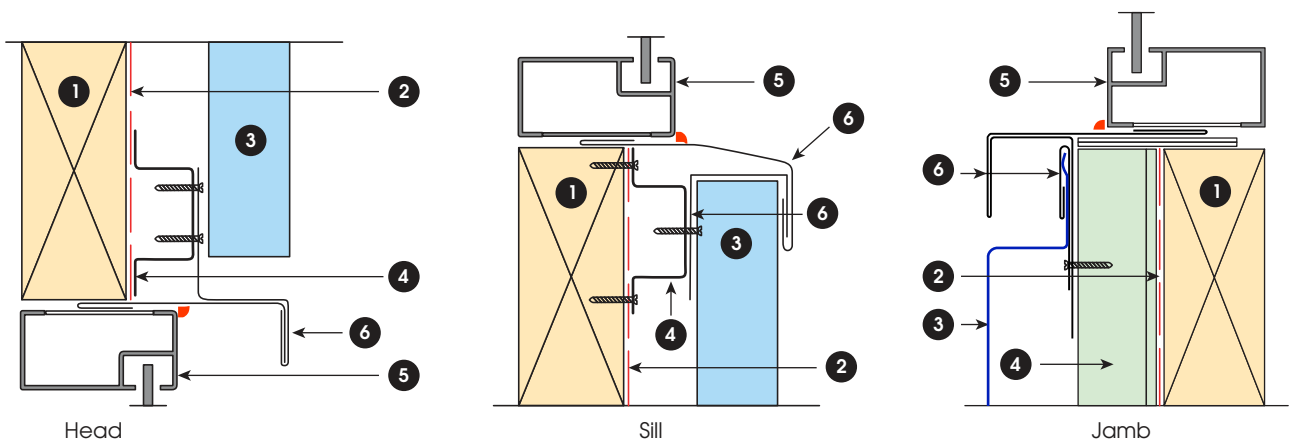

- 1 Substructure supplied by others
- 2 Breathable waterproofing membrane shown dashed
- 3 Vertical Expression™ panel
- 4 Top hat or batten
- 5 Window supplied by others
- 6 Flashing

Typical window detail

Wall Cladding - Horizontal Application Installation on Battens

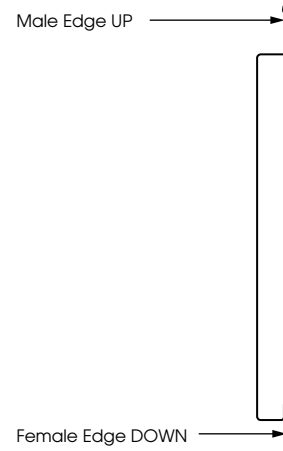
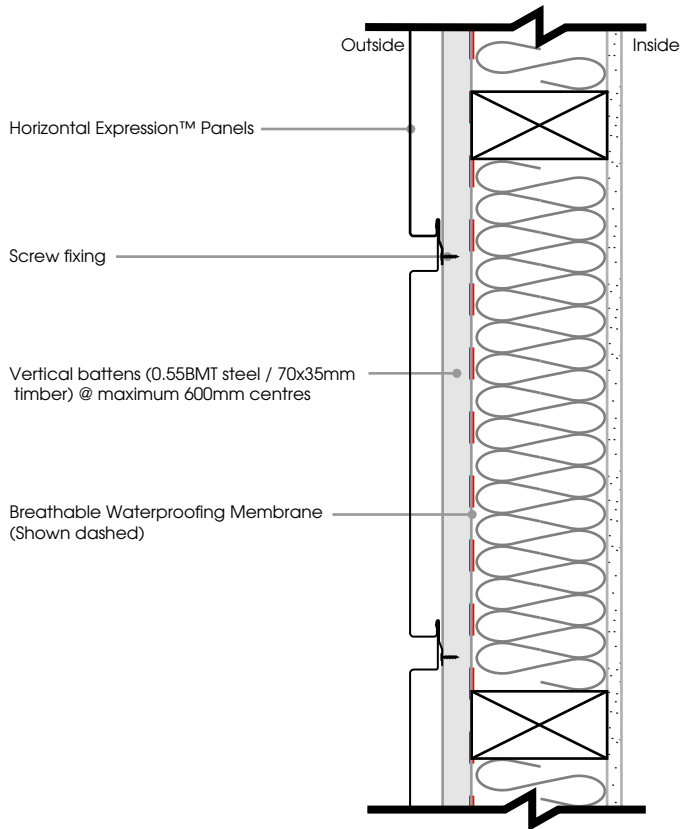

OBS.: On horizontal applications, Expression™ panels must be oriented with male edge upwards and female edge downwards for appropriate and sealed installation.

Expression™ Panels installed on battens - horizontal application - breathable build up - wall section

Installation Steps

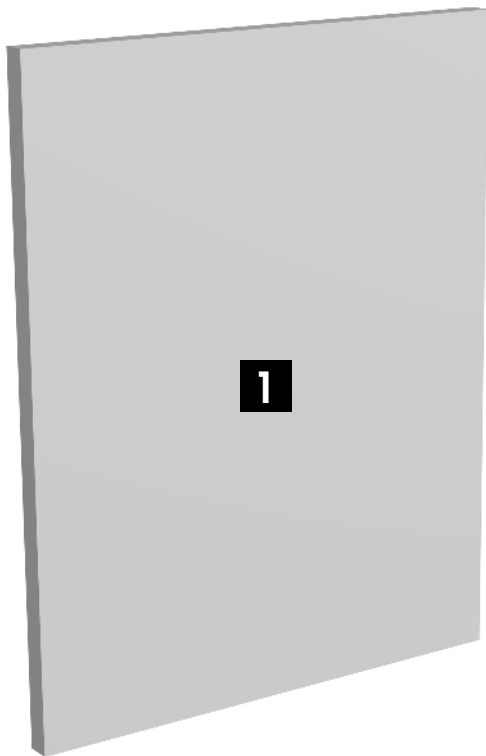

- 1** Ensure wall structure is levelled and plumb.
*Wall structure not shown for clarity.

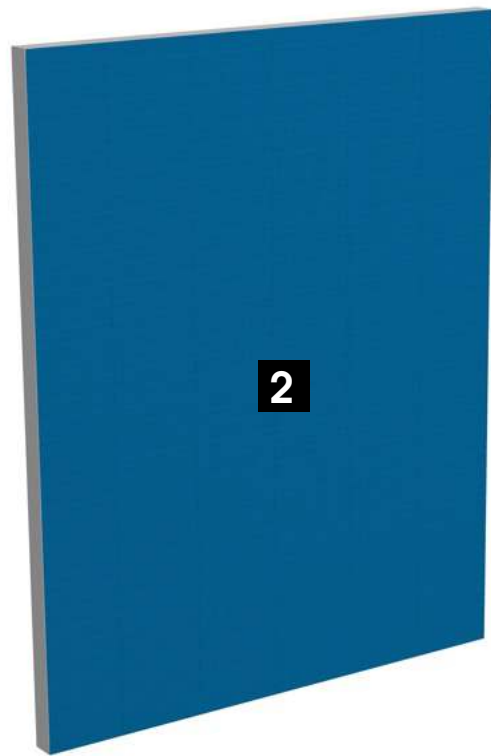

- 2** Apply a layer of breathable waterproofing membrane to the structure. Ensure structure is protected and sealed.

Wall Cladding - Horizontal Application Installation on Battens

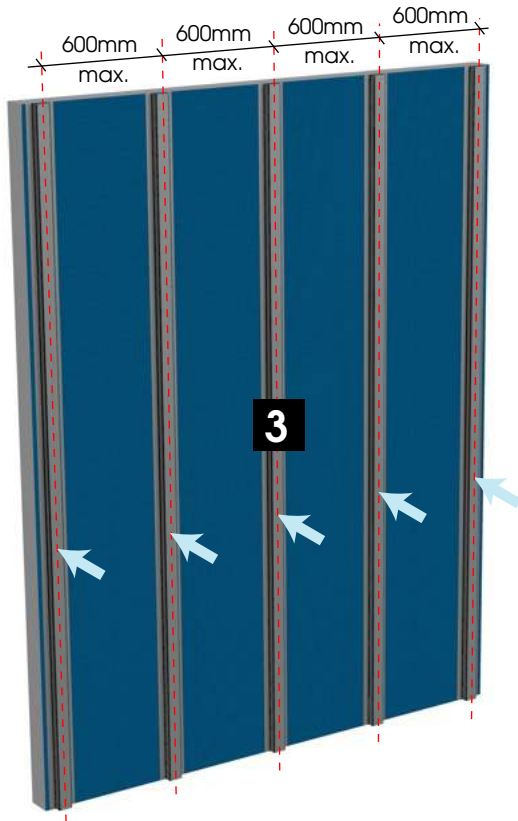

3 Install tophats vertically over membraned wall, at maximum 600mm centres. Install extra tophats for flashings support if required.



4 Install toe mould flashing at bottom and custom top flashing with a starter strip at top.

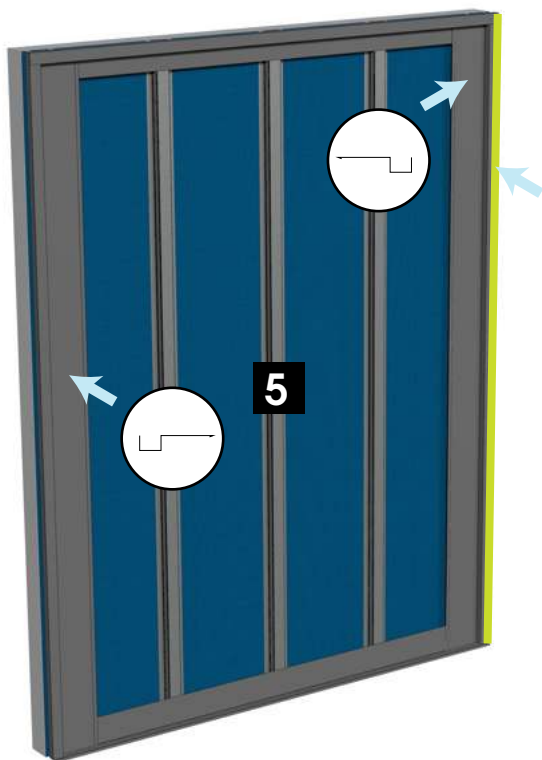

5 Install custom side flashings. Ensure side flashings are over toe mould flashing. Seal side flashings against the wall if required.

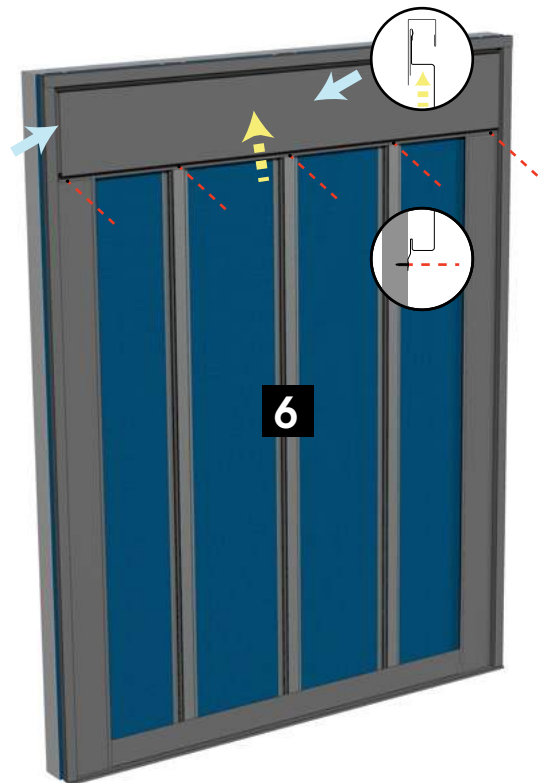

6 Install first Expression™ panel by sliding male edge into starter strip. Fix panels to tophats with recommended fasteners. For better waterproofing and aesthetics, notch and stop end panel ends.

Wall Cladding - Horizontal Application Installation on Battens

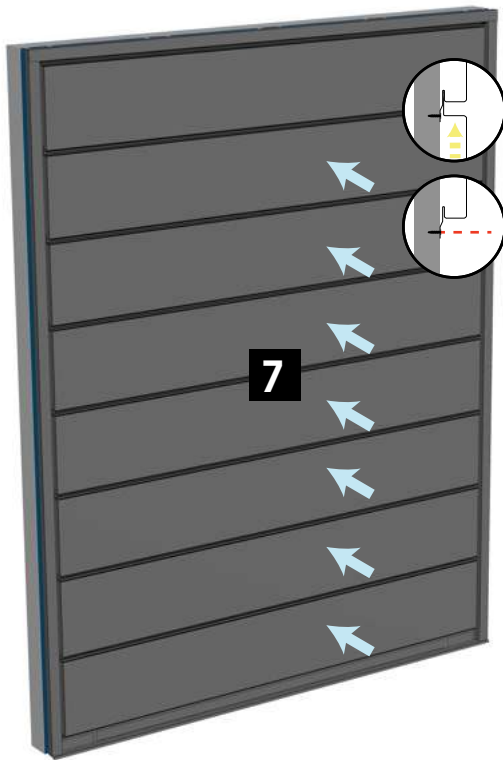

- 7** Slide up the next Expression™ panel so its male edge is fully inserted into the upper panel female edge. Fix the panel to tophats using recommended fasteners. Repeat the step as required.

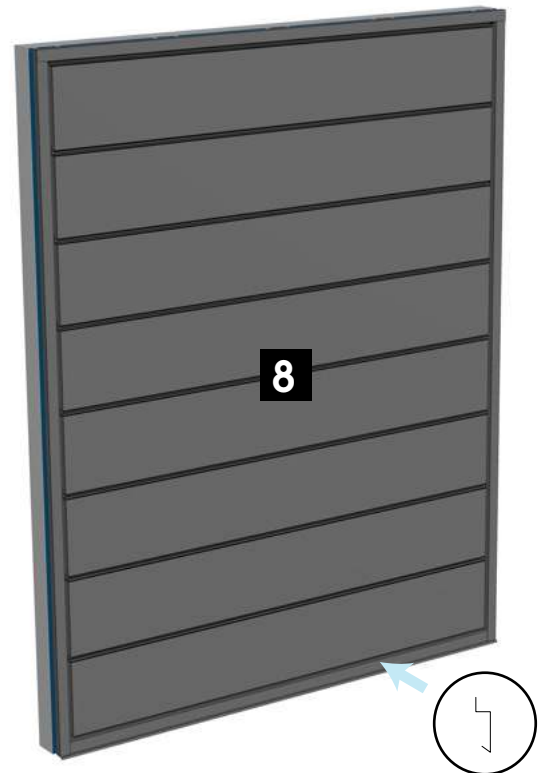

- 8** Install custom bottom flashing to finalise the installation.

Wall Cladding - Horizontal Application Flashing Details - Installation on battens

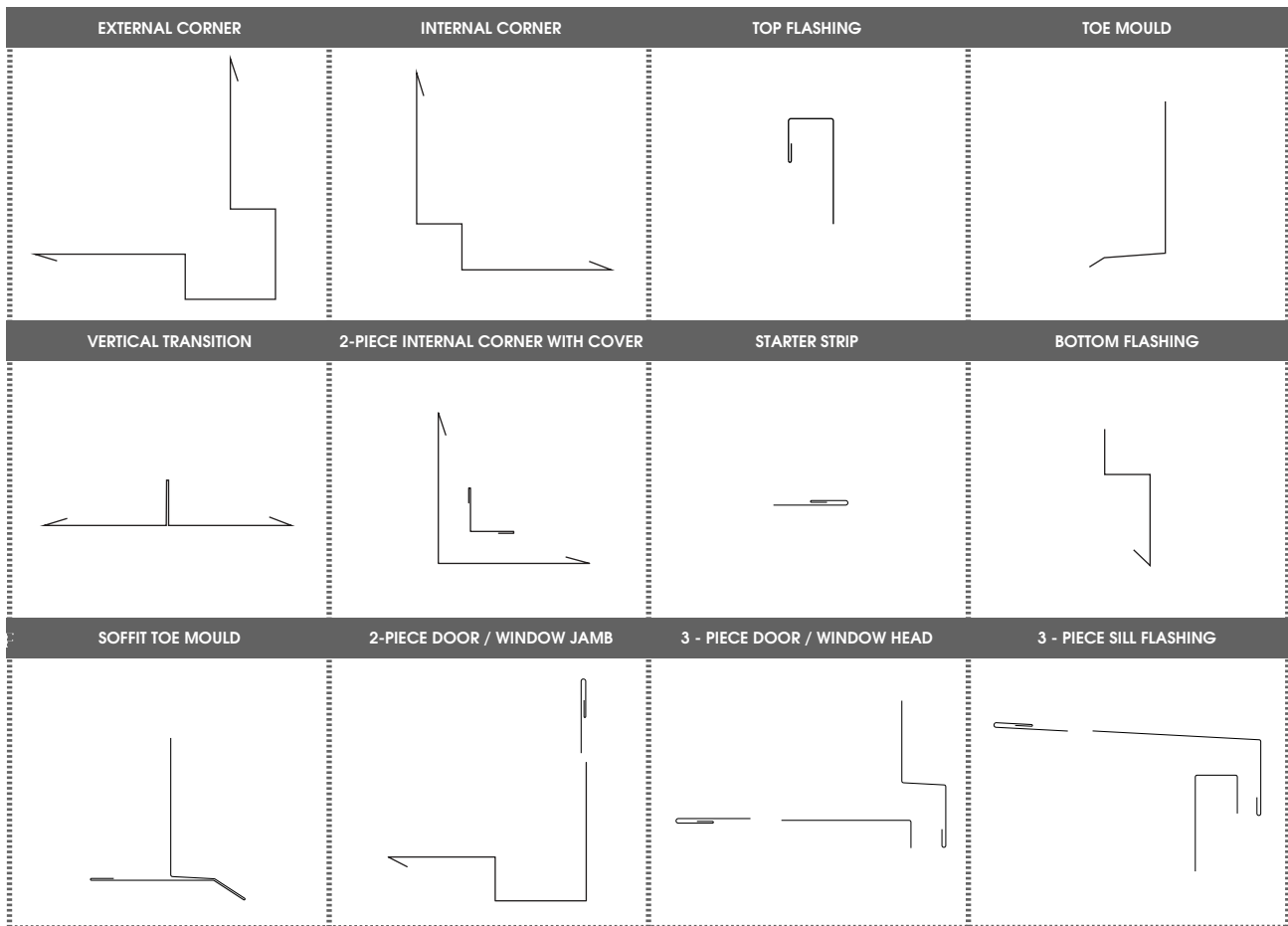

Above are the most common flashing profiles for the Expression™ panel system. On site requirements might change flashings shape and dimensions. It is the responsibility of the installer to ensure installation is compliant to Australian Standards.

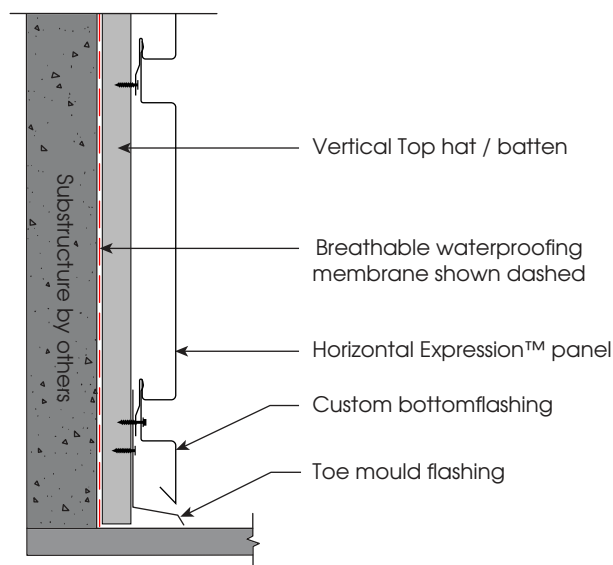

Typical bottom flashing detail - cross section

Wall Cladding - Horizontal Application Flashing Details - Installation on battens

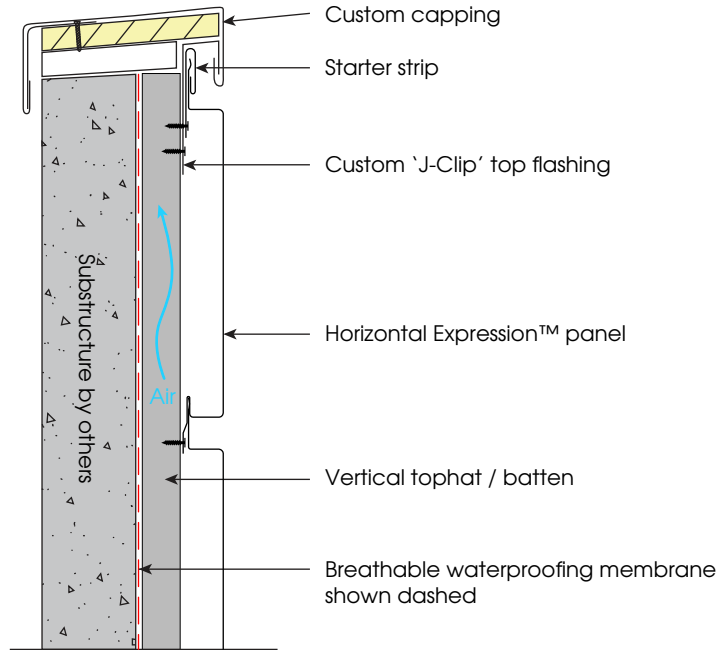

Typical parapet detail

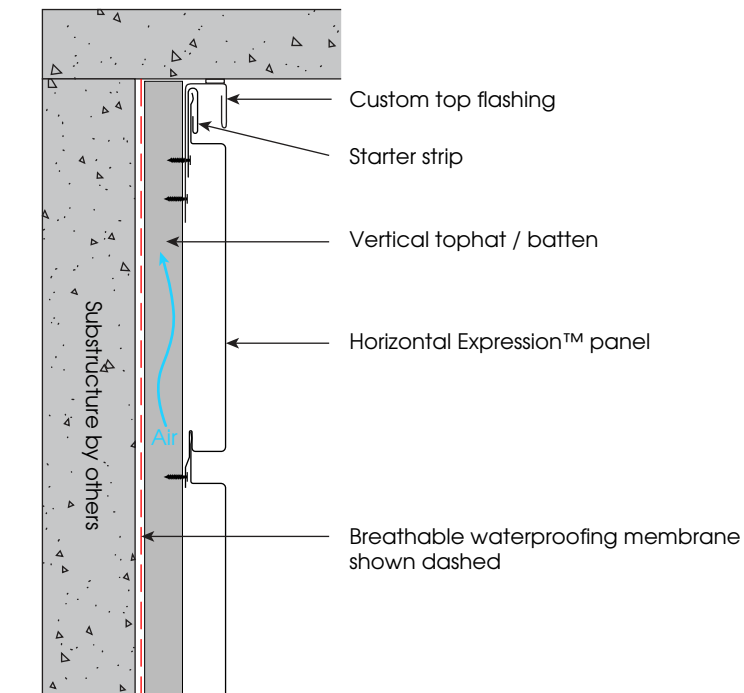

Typical top of wall detail

Wall Cladding - Vertical Application Flashing Details - Installation on battens

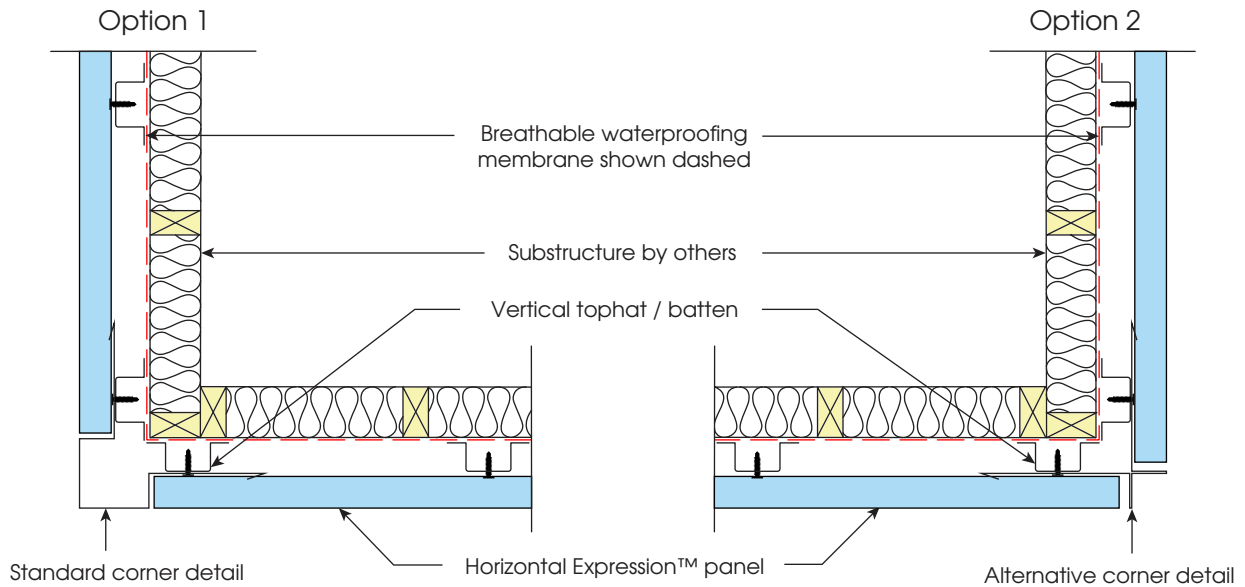

Typical external corner detail

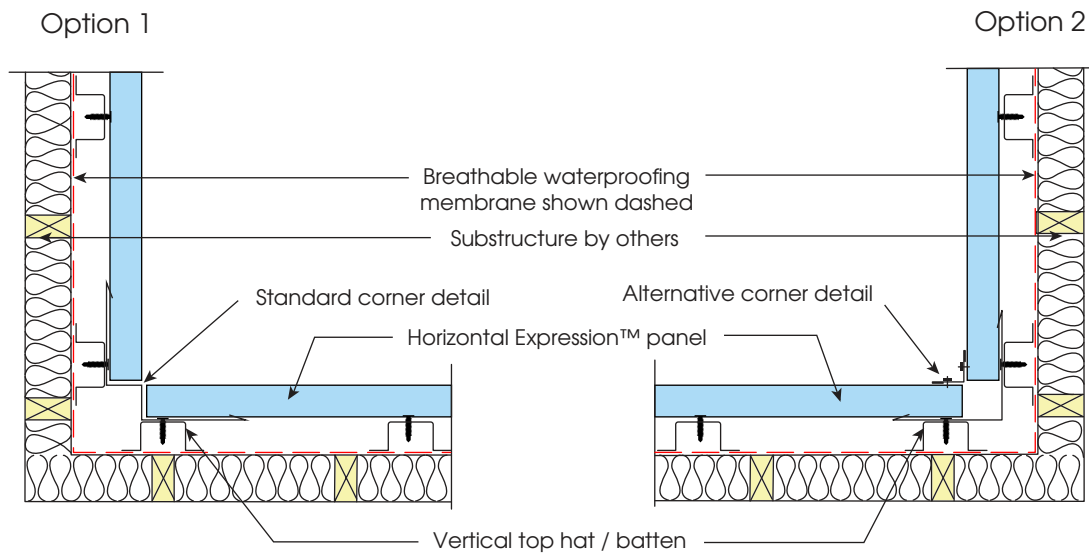

Typical internal corner detail

Wall Cladding - Horizontal Application Flashing Details - Windows

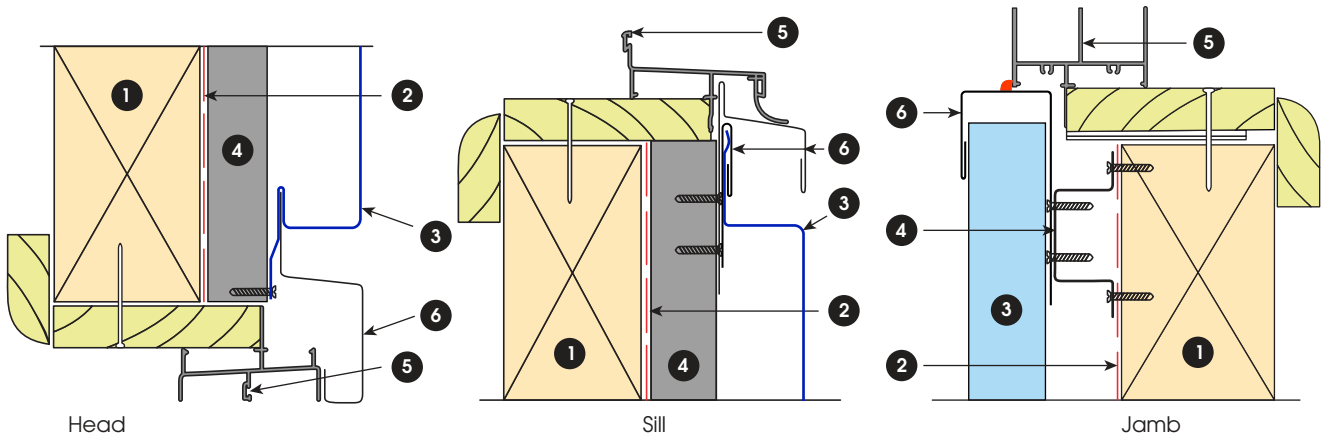

- 1 Substructure supplied by others
- 2 Breathable waterproofing membrane shown dashed
- 3 Horizontal Expression™ panel
- 4 Vertical top hat or batten
- 5 Window supplied by others
- 6 Flashing

Typical timber reveal window detail

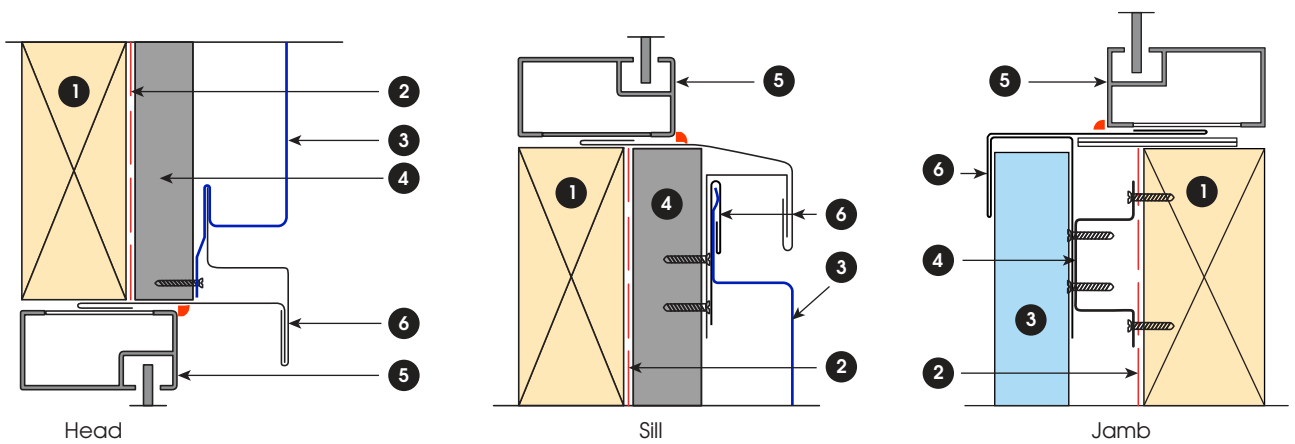

- 1 Substructure supplied by others
- 2 Breathable waterproofing membrane shown dashed
- 3 Horizontal Expression™ panel
- 4 Vertical top hat or batten
- 5 Window supplied by others
- 6 Flashing

Typical window detail



Expression™

Wall Cladding

Flashing details on plywood

Wall Cladding - Vertical Application Installation on Plywood

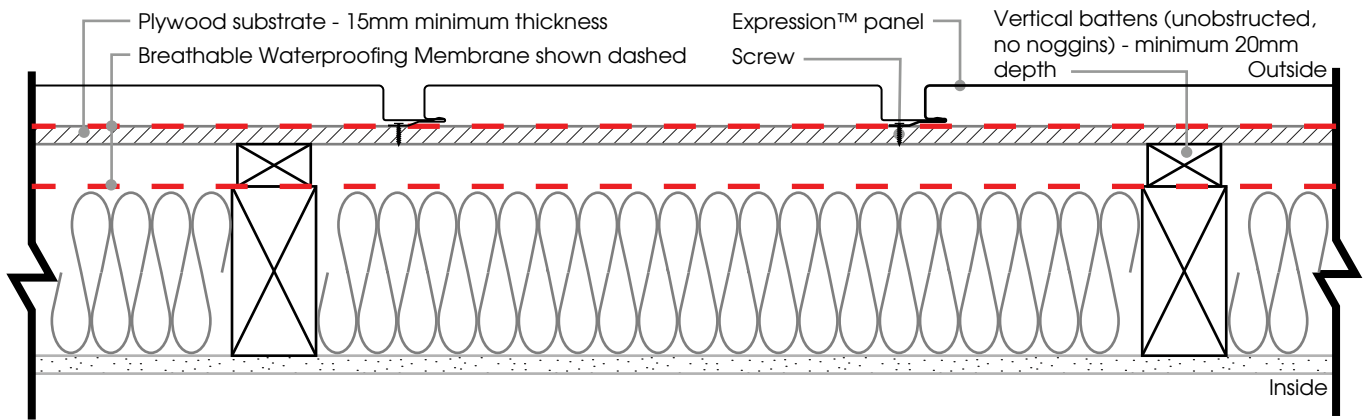

Expression™ Panels installed on plywood - vertical application - breathable build up - wall section

Installation Steps

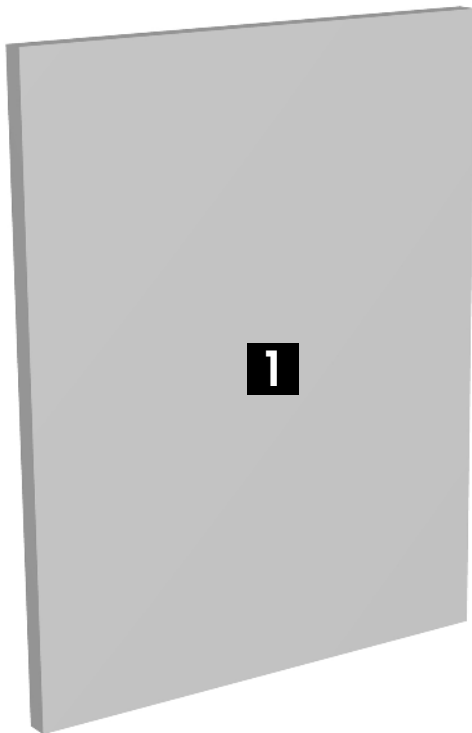

- 1** Ensure wall structure is levelled and plumb.
*wall structure not shown for clarity.



- 2** Apply a layer of breathable waterproofing membrane to the structure. Ensure structure is protected and sealed.

Wall Cladding - Vertical Application Installation on Plywood

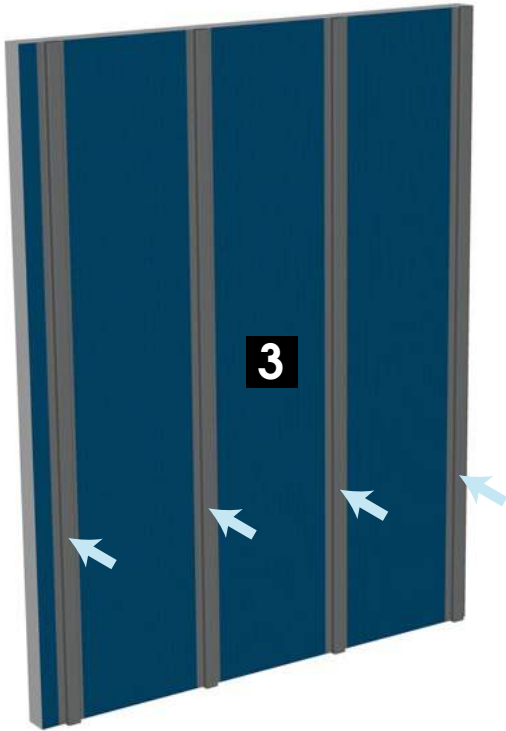

- 3** Install tophats (minimum depth 20mm) vertically over membraned wall at maximum 600mm centres, to create a ventilation cavity to mitigate condensation.



- 4** Install a layer of 15mm plywood (minimum CD grade) over tophats.



- 5** Install another layer of breathable waterproofing membrane over plywood.



- 6** Install Top Flashing and Toe Mould Flashing.

Wall Cladding - Vertical Application Installation on Plywood



7 Install Side Wall Flashing, and then install Starter Strip. Seal Side Wall Flashing against the wall.



8 Apply a weathertight sealing tape to seal flashings as required.



9 Slide up the first Expression™ panel into Top Flashing.

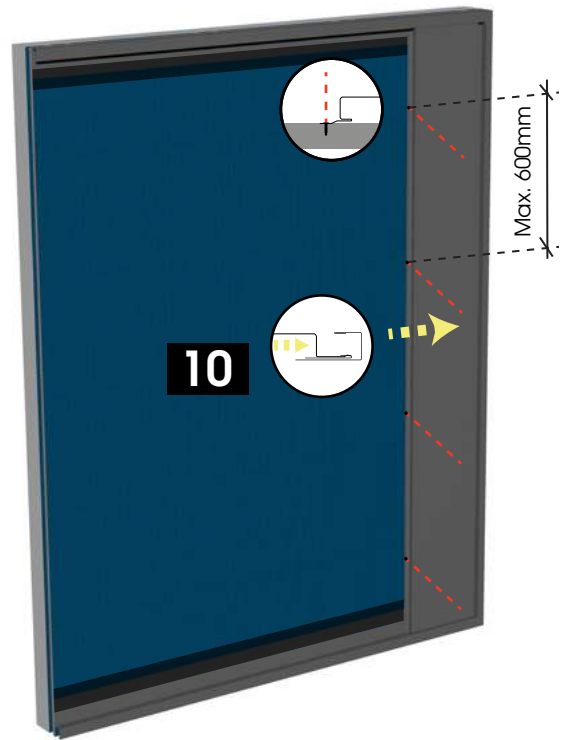

10 Slide Expression™ panel sideways into starter strip, and fix Expression™ panel to the plywood substrate using recommended fasteners.

Wall Cladding - Vertical Application Installation on Plywood

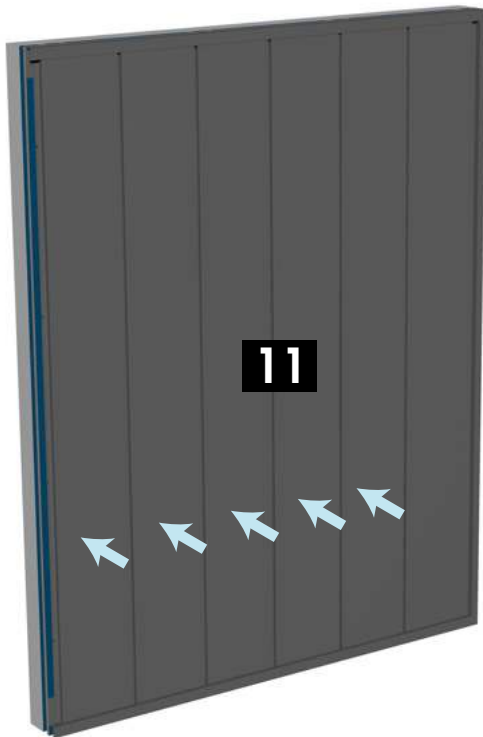

11 Repeat step 8 as required until the wall is covered.

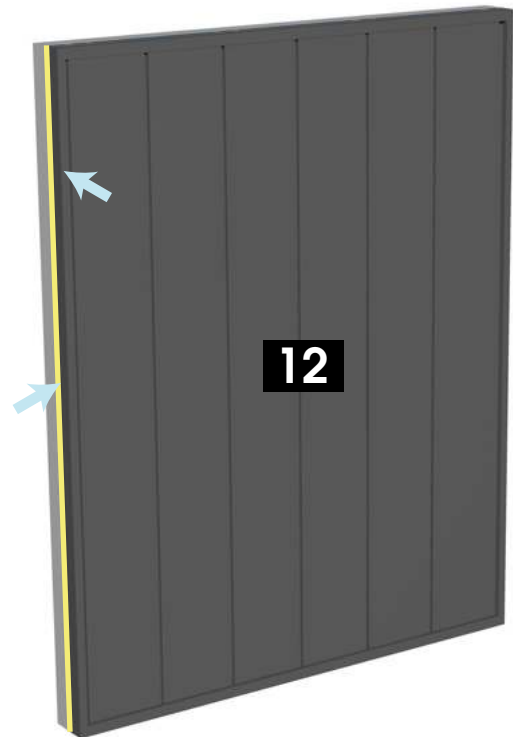

12 Install Custom Wall Flashing over last Expression™ panel, using butyl tape and screws with washer. Seal Custom Wall Flashing against the wall.

Wall Cladding - Vertical Application Flashing Details - Installation on plywood



Above are the most common flashing profiles for the Expression™ panel system. On site requirements might change flashings shape and dimensions. It is the responsibility of the installer to ensure installation is compliant to Australian Standards.

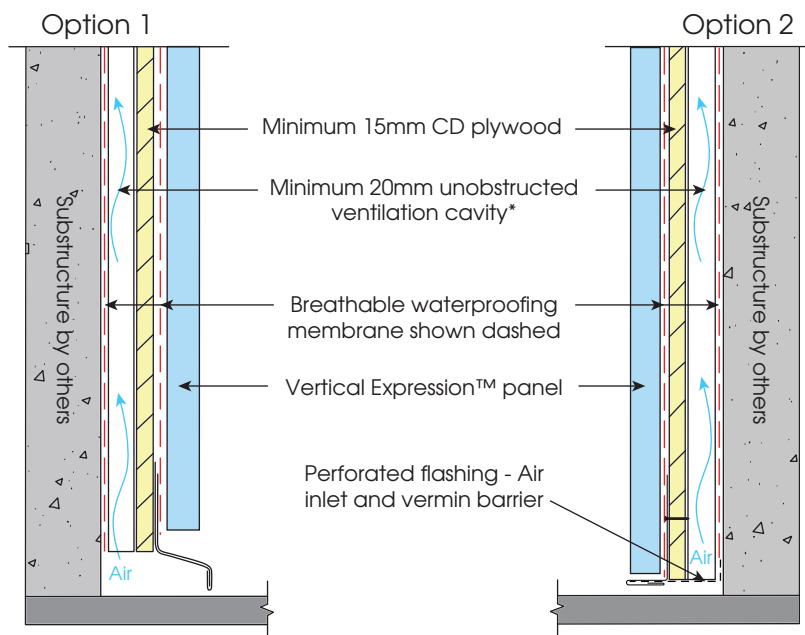

*Ventilation cavities require air inlets (bottom) and air outlets (top) to function efficiently. Please consult with our team for custom project requirements.

Typical bottom flashing detail - cross section

Wall Cladding - Vertical Application Installation on Plywood

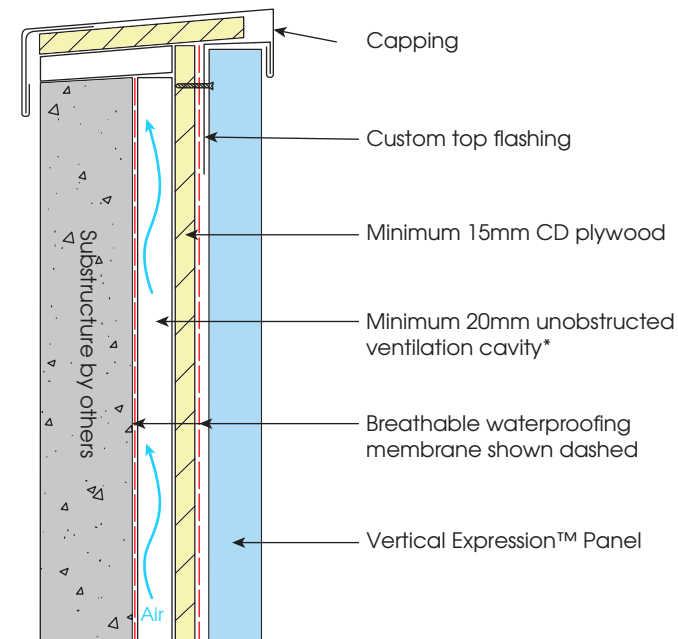

*Ventilation cavities require air inlets (bottom) and air outlets (top) to function efficiently. Please consult with our team for custom project requirements.

Typical parapet detail

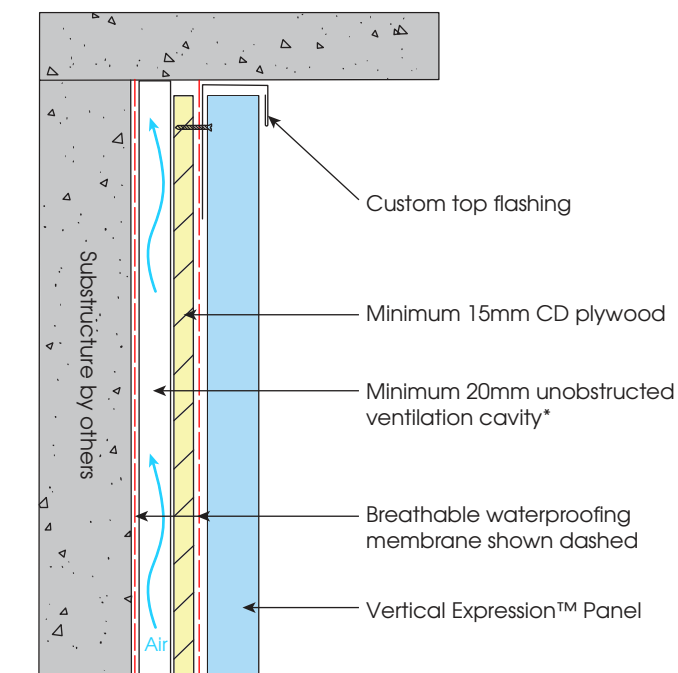

*Ventilation cavities require air inlets (bottom) and air outlets (top) to function efficiently. Please consult with our team for custom project requirements.

Typical top of wall detail

Wall Cladding - Vertical Application Flashing Details - Installation on plywood

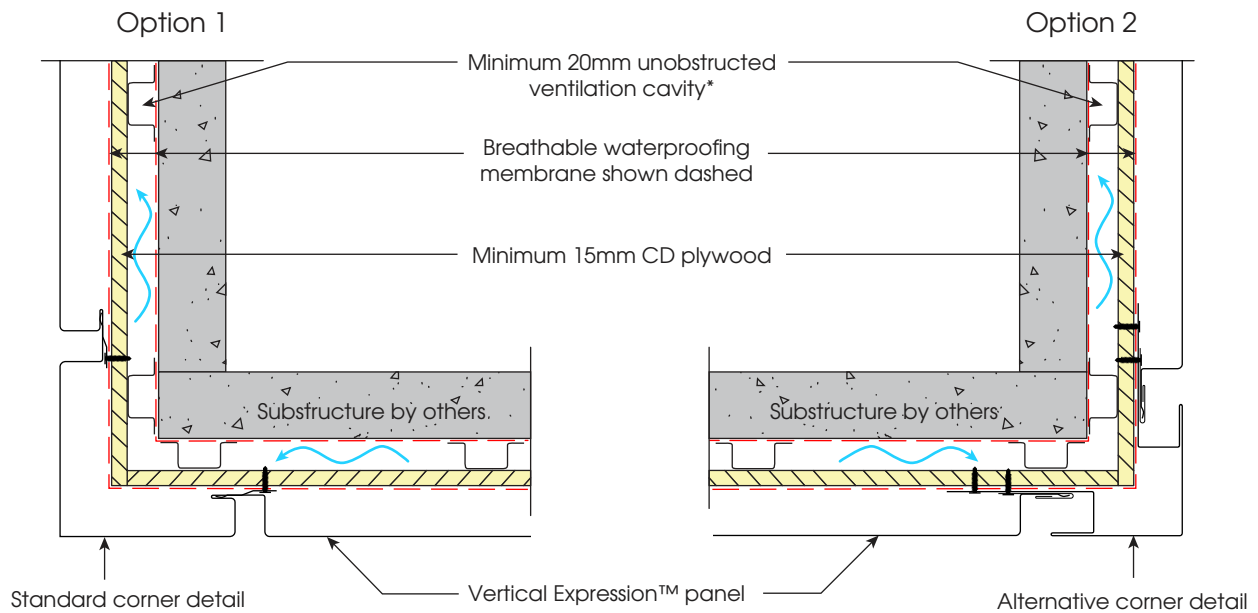

Typical external corner detail

*Ventilation cavities require air inlets (bottom) and air outlets (top) to function efficiently. Please consult with our team for custom project requirements.

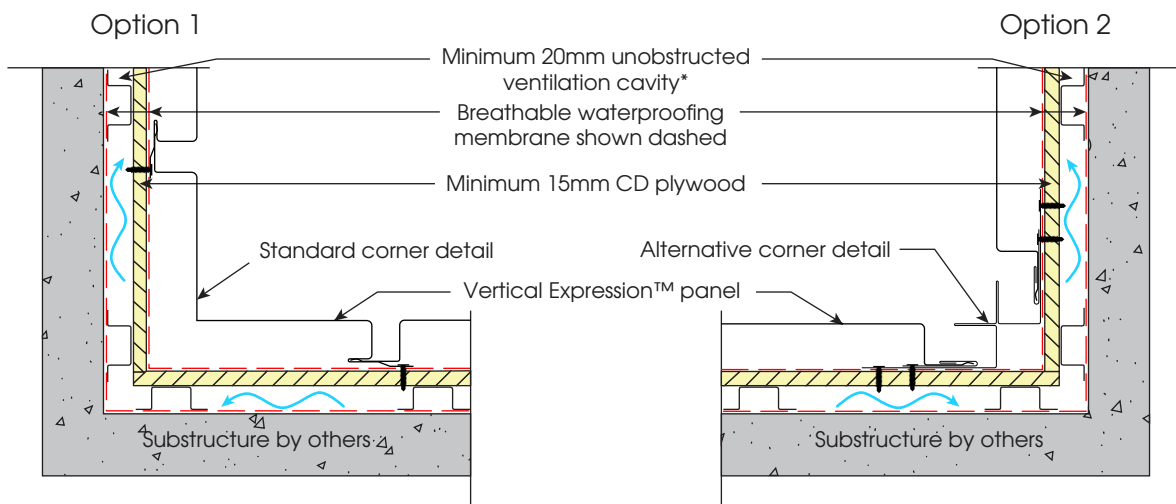

Typical internal corner detail

*Ventilation cavities require air inlets (bottom) and air outlets (top) to function efficiently. Please consult with our team for custom project requirements.

Wall Cladding - Vertical Application Flashing Details - Installation on plywood

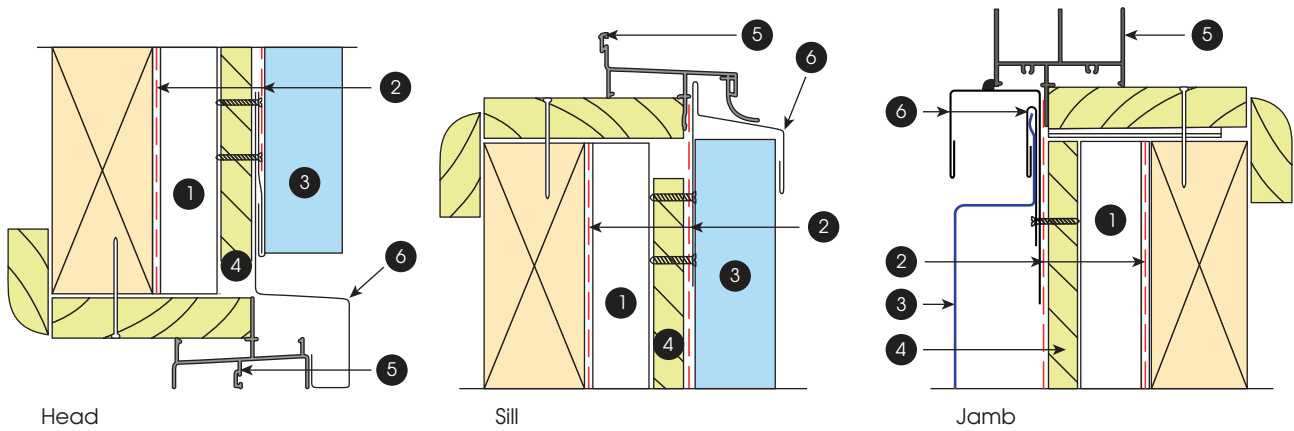

- 1 Substructure supplied by others
- 2 Breathable waterproofing membrane shown dashed
- 3 Vertical Expression™ panel
- 4 Top hat or batten
- 5 Window supplied by others
- 6 Flashing

Typical timber reveal window detail

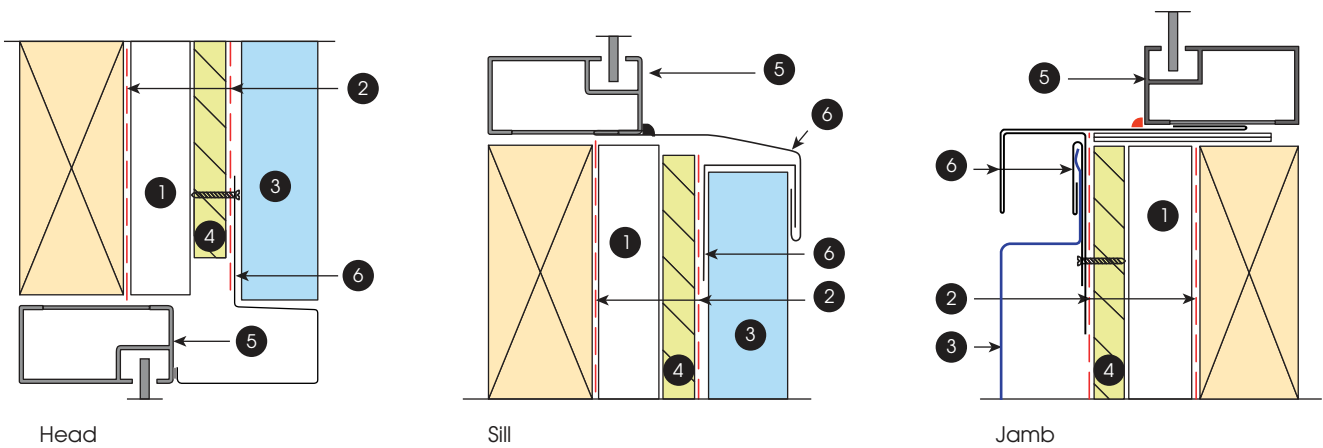

- 1 Substructure supplied by others
- 2 Breathable waterproofing membrane shown dashed
- 3 Vertical Expression™ panel
- 4 Top hat or batten
- 5 Window supplied by others
- 6 Flashing

Typical window detail

No1 Roofing & Building Supplies



No1 Architectural Panel Systems
Manufactured by No1 Roofing & Building Supplies

1300 742 011

aps@no1roofing.com.au

www.no1aps.com.au

Non Cyclonic - Version One